

## CW-WZ-0124

### Lora External Antenna

#### Key Features

Frequency: 915MHZ

IPEX Connector

External Rubber

Dimensions 43.3\*12 mm



## 1. Antenna Electrical Characteristics

Band (MHz)	
Frequency (MHz)	915MHZ
VSWR	2.0
Efficiency (%)	50.02%
Peak Gain (dBi)	1.42
Impedance (Ohm)	50
Polarisation	Vertical
Max. Input Power (W)	10
Connector Type	IPEX

## 2. Material and environmental characteristics

Inner structure	Spring
Material of Plastic	ABS+PC
Cable Type	RF1.13
Connector Type	IPEX
Dimensions (mm)	43.3*12MM
Antenna color	Black
Operation Temperature	-40 to +80
Storage Temperature	-40 to +80
Antenna Storage life(year)	10
Substance Compliance	ROHS

REV	Date	Description
X1	2023/04/12	New issue

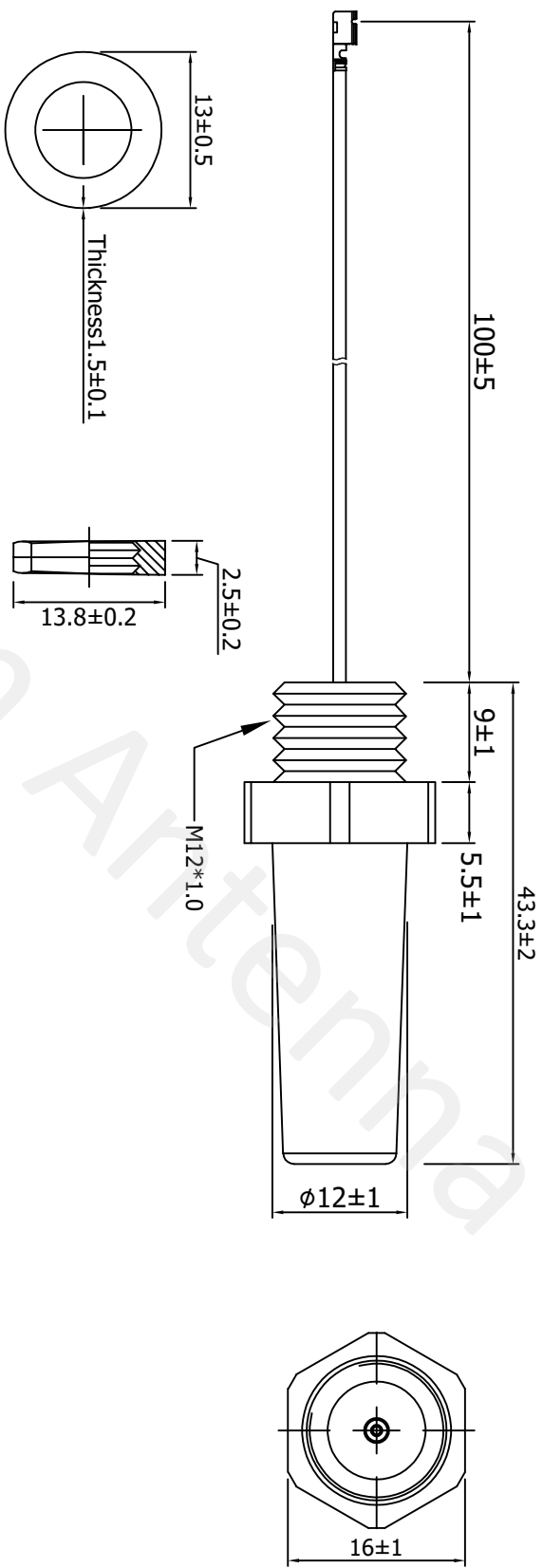

Specification(Free Test):  
 Frequency Range: 915MHZ  
 Impedance: 50Ω  
 V.S.W.R: ≤2.0  
 100% Continuity,short and open circuit test  
 Materials,parts and process must by environmentally (ROHS)

NO	Name	Description	Q'ty	Remark
1	Connector	φ1.13 I-PEX II(equivalents)	1	
2	Cable	φ1.13 Black double tin wire	1	
3	Fixing seat	Copper nickel plating	1	
4	Spring	Brass	1	
5	Radome	Black ABS+PC	1	
6	Nut	Brass plated gold	1	
7	Dust cap	Red silicone	1	

NO	Name	Description	Q'ty	Remark
XX	±5.0	Approved		
X	±3.0	Customer		
X	±1.0	Part NO.		
XX	±0.2	Part name	External antenna	
.XXX	±0.1	CW P/NO.	CW-WZ-0124	
		REV	Unit	File
		X1	m/m	Sheet :
				1/1



## 4. Antenna test parameters

### Antenna Measurement Conditions:

Mounted on Ground Plane of 280 x 80 mm

Measured in Certified 3D Anechoic Chamber

The network analyzer is Agilent 5071c

The comprehensive tester is Agilent cmv500

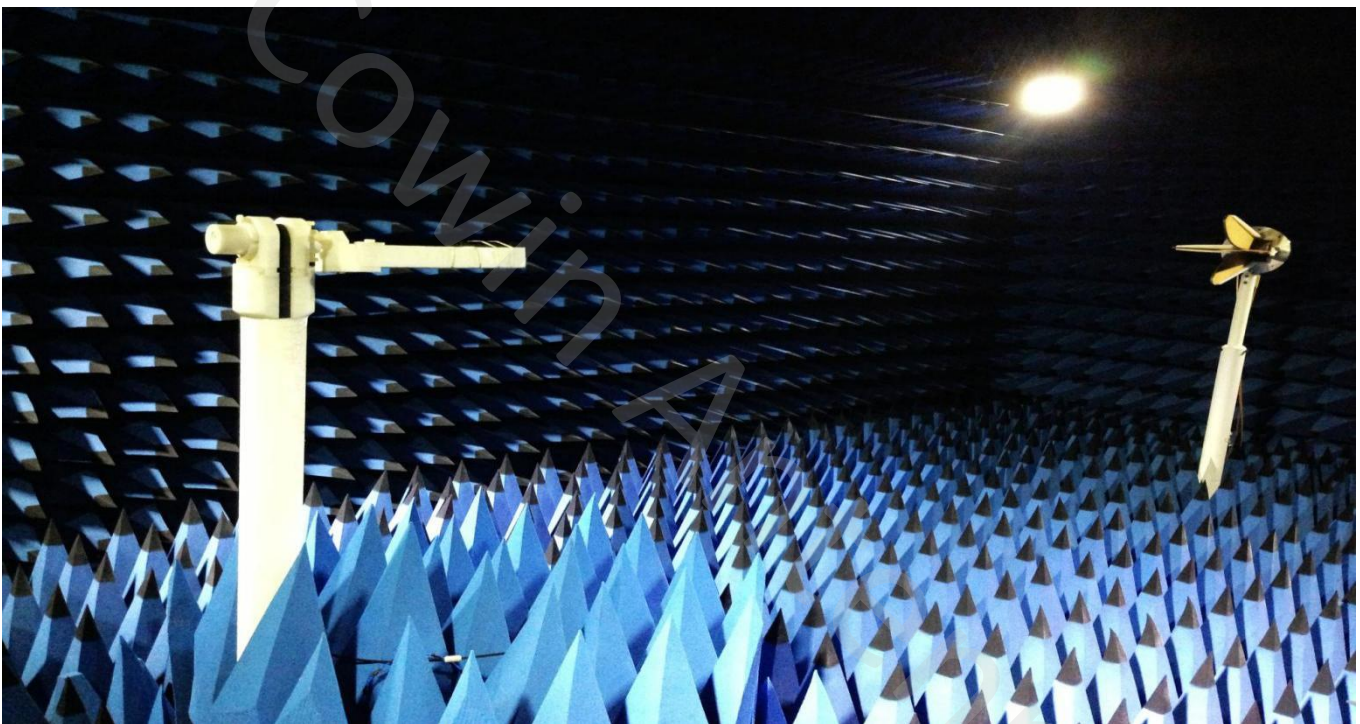

## 4.1 VSWR

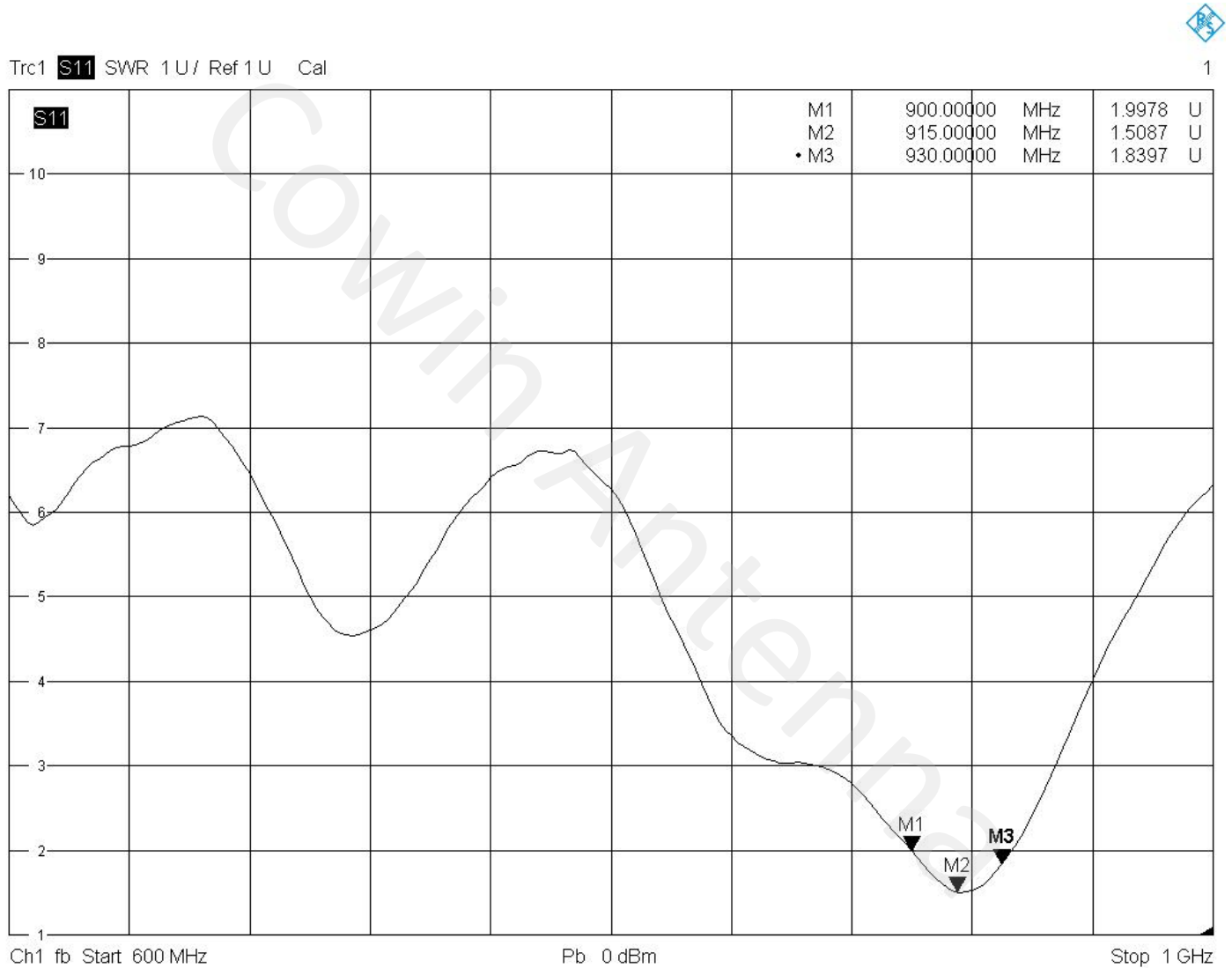

4/11/2023, 10:43 PM

## 4.2 Efficiency

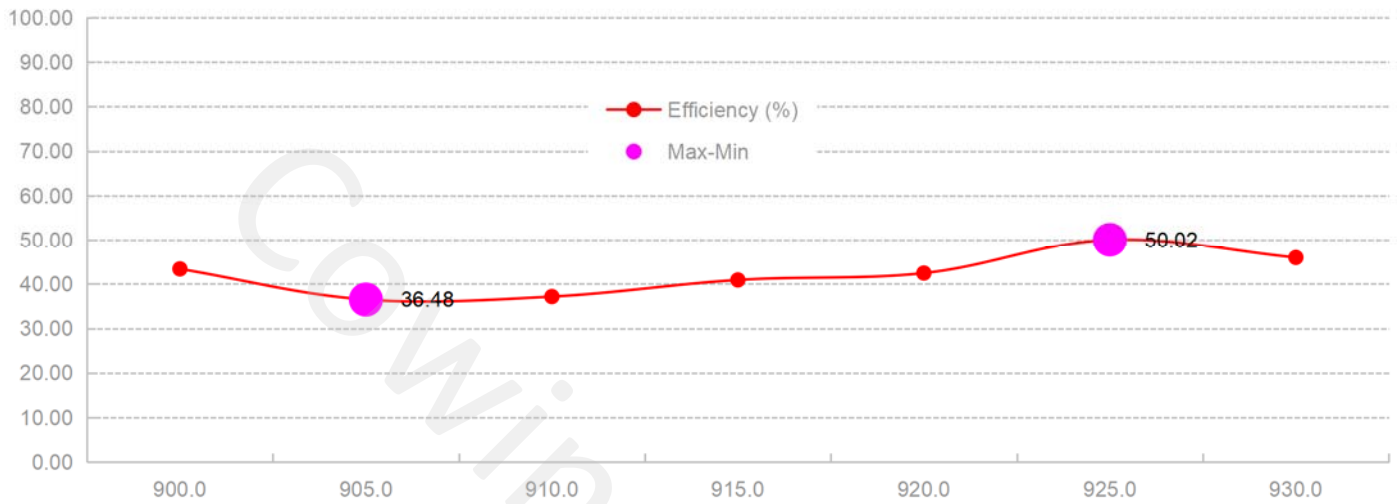

## 4.3 Peak gain

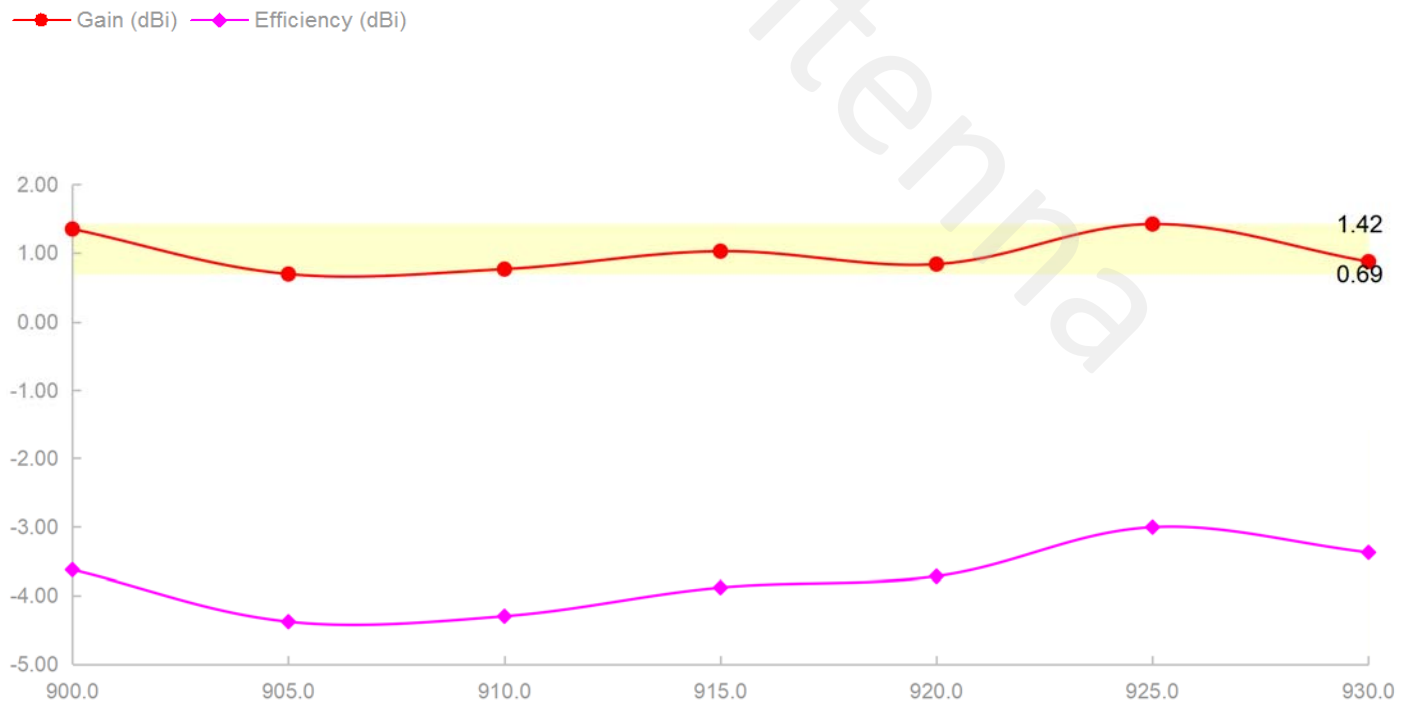

## 4.4 3D&2D Radiation Patterns

900.0MHz H+V, Eff: 43.4%

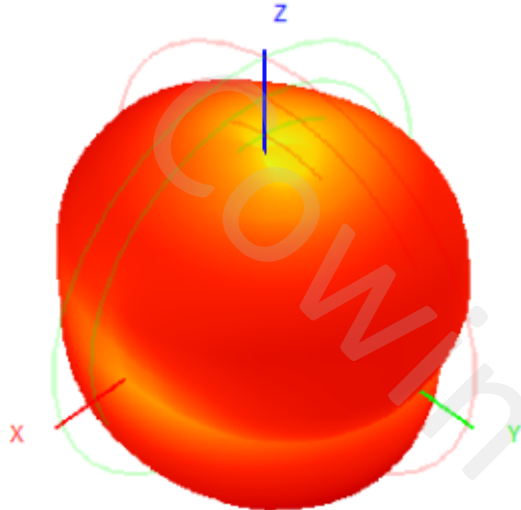

Back View

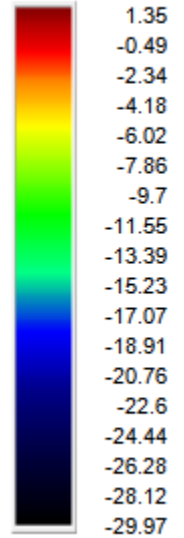
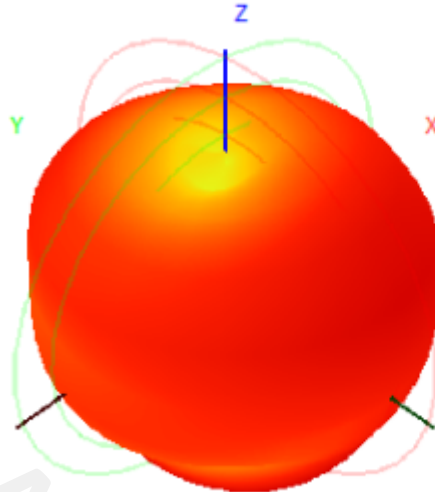

900.0MHz Total(E1-XZ), Max= -0.19dBi

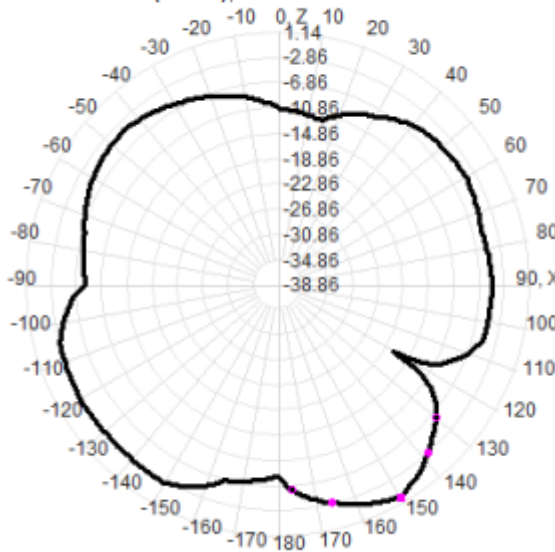

900.0MHz Total(E2-YZ), Max= 1.14dBi

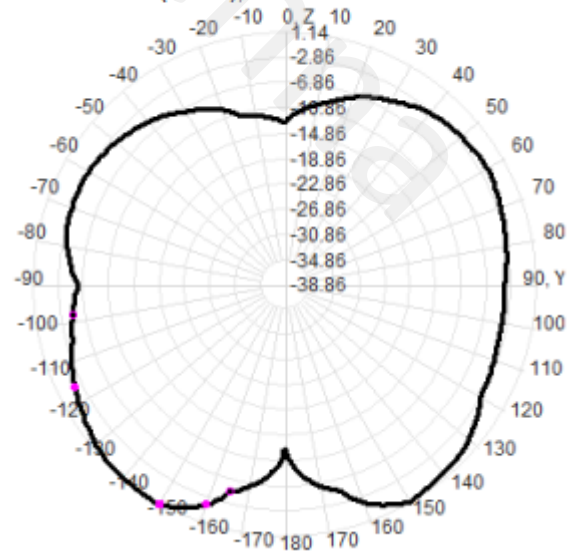



915.0MHz H+V, Eff: 40.9%

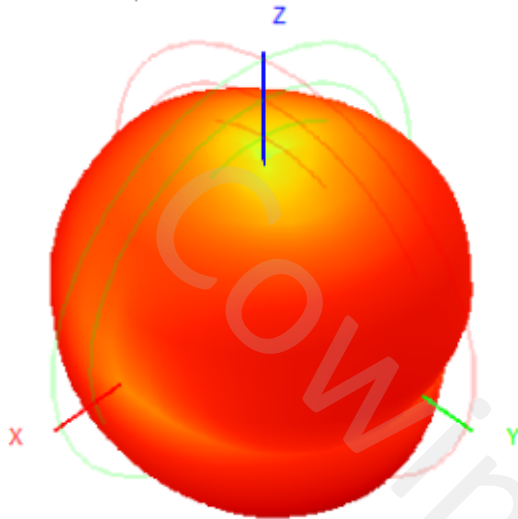

Back View

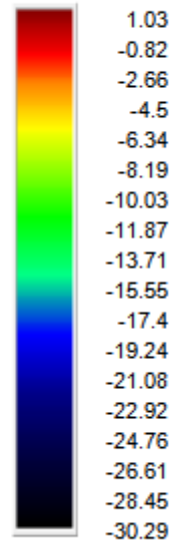
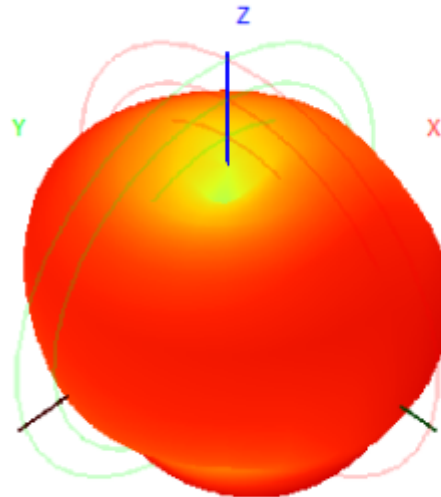

915.0MHz Total(E1-XZ), Max= -0.60dBi

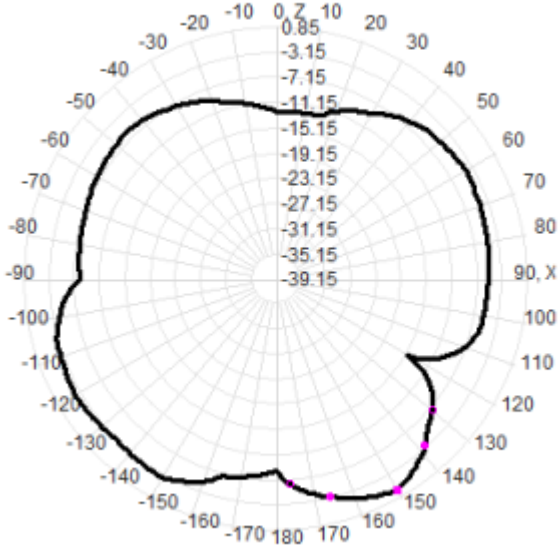

915.0MHz Total(E2-YZ), Max= 0.85dBi

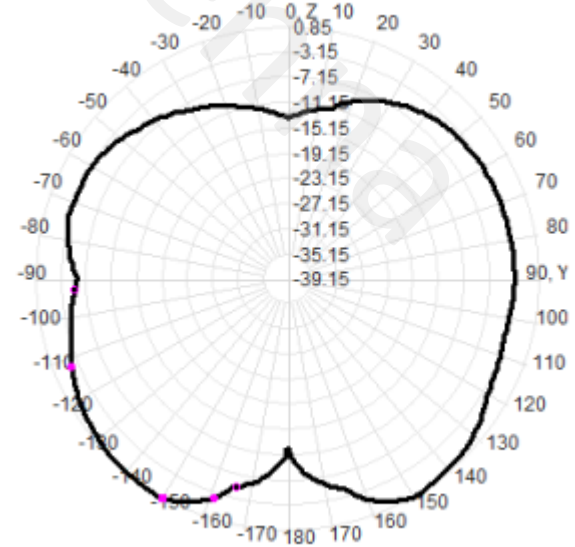



930.0MHz H+V, Eff: 46.0%

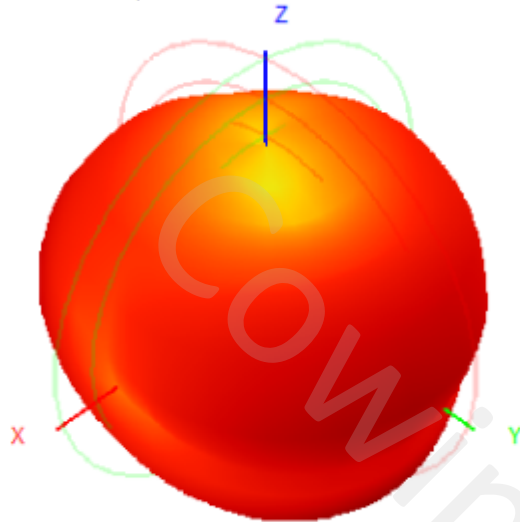

Back View

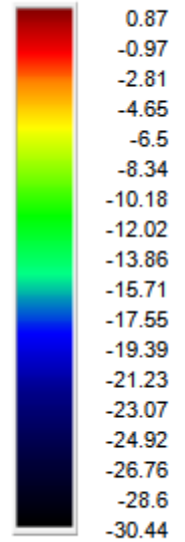
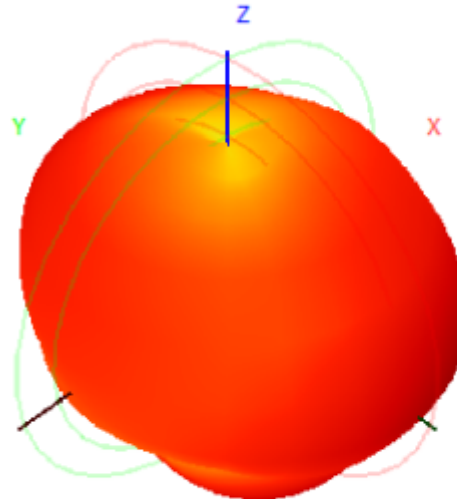

930.0MHz Total(E1-XZ), Max=-2.38dBi

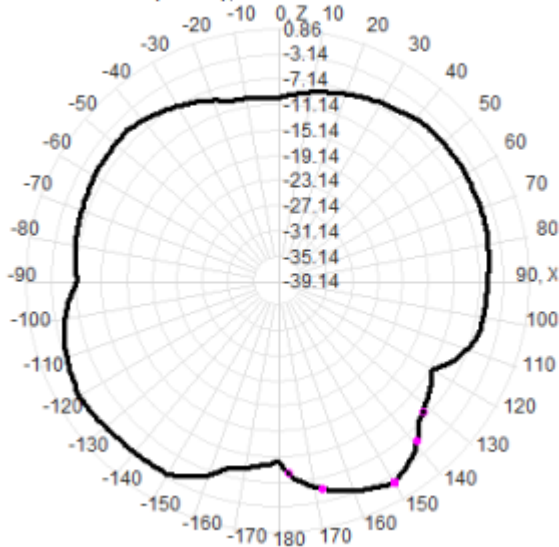

930.0MHz Total(E2-YZ), Max= 0.86dBi

