

CW-WZ-0002

2.4G/5.8G External Antenna

Key Features

Frequency: 2.4G-2.5G/4.9G-5.85G

SMA Male Connector

External Rubber

Dimensions 158*17 mm



1. Antenna Electrical Characteristics

Band (MHz)		
Frequency (MHz)	2.4G-2.5G	4.9G-5.85G
VSWR	2.5:1	2.5:1
Efficiency (%)	56.5%	49.45%
Peak Gain (dBi)	1.99	3.52
Impedance (Ohm)		50
Polarisation		Vertical
Max. Input Power (W)		10
Connector Type		SMA male

2. Material and environmental characteristics

Material of PCB	FR4
Material of Plastic	PC+PBT/ABS
Cable Type	RG178
Connector Type	SMA male
Dimensions (mm)	158*17MM
Antenna color	Black
Operation Temperature	-40 to +80
Storage Temperature	-40 to +80
Antenna Storage life(year)	10
Substance Compliance	ROHS

REV	Date	Description
X1	2021/08/27	New issue

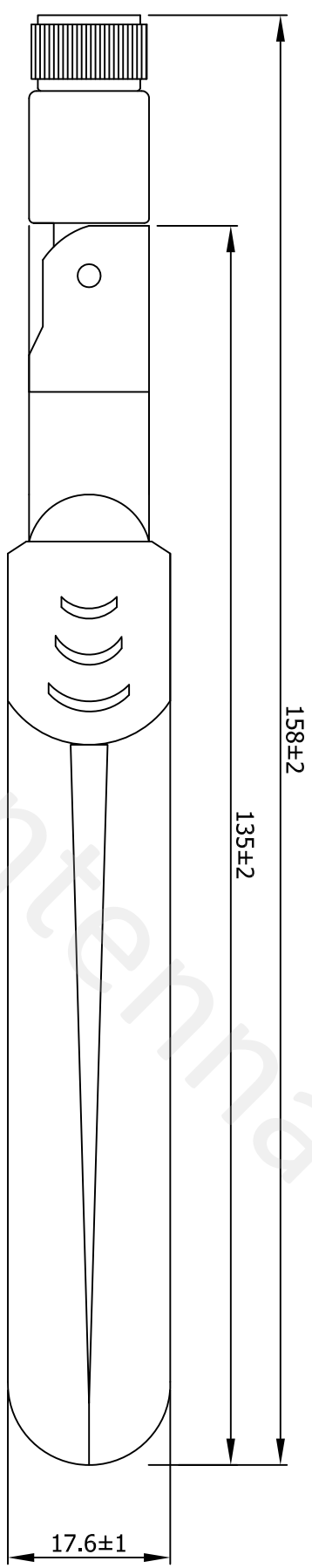

Specification(Free Test):
 Frequency Range: 2.4-2.5G/4.9-5.85G
 Impedance: 50Ω
 V.S.W.R: ≤2.5

6	Radome	Black ABS	1	
5	Lower fixing seat	Black PC+PBT	1	
4	Upper fixing seat	Black PC+PBT	1	
3	Connector	Black SMA male	1	
2	Cable	RG178 Single silver wire	1	
1	PCB	FR4	1	

NO	Name	Description	QTY	Remark
XX.	±5.0	Approved		
X.	±3.0	Customer		
.X	±1.0	Part NO.		
.XX	±0.2	Part name		External antenna
.XXX	±0.1	CW P/NO.		CW-WZ-0002
		REV	Unit	File :
		X1	m/m	Sheet :

 Cowin Antenna	
---	--

4. Antenna test parameters

Antenna Measurement Conditions:

Mounted on Ground Plane of 280 x 80 mm

Measured in Certified 3D Anechoic Chamber

The network analyzer is Agilent 5071c

The comprehensive tester is Agilent cmv500

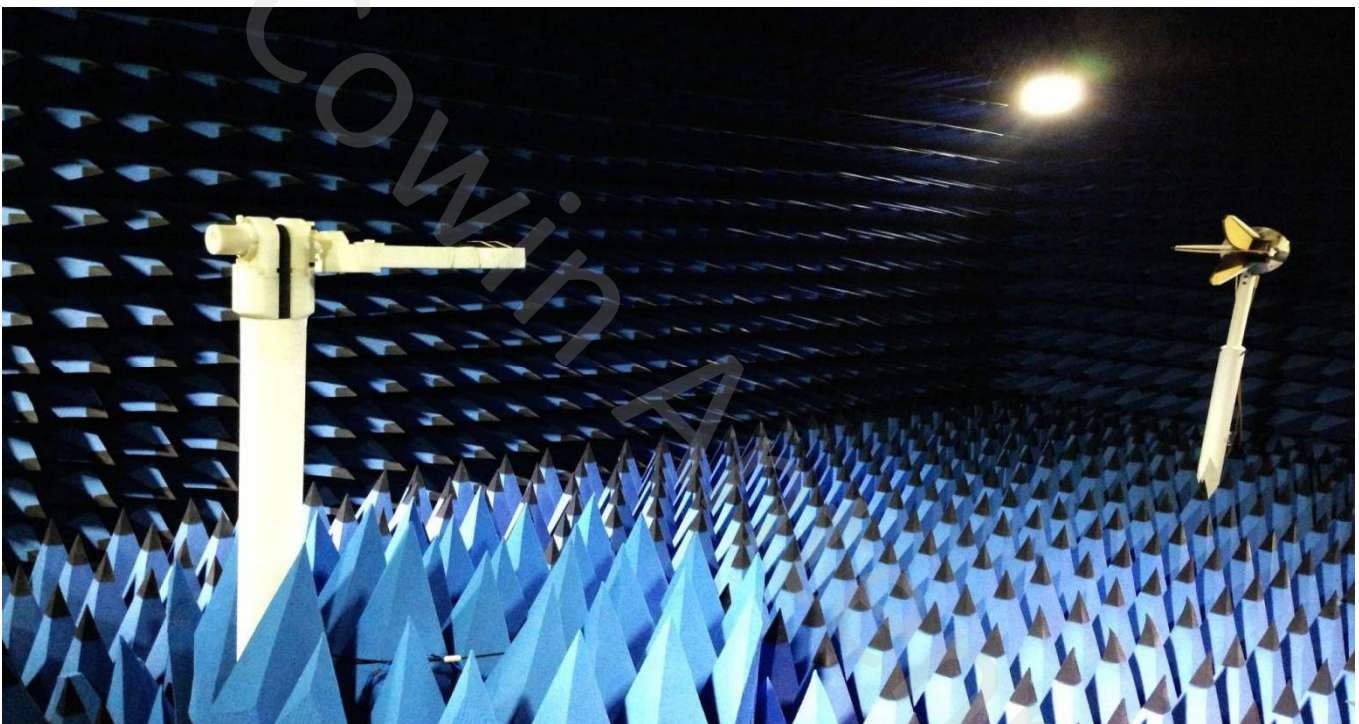

4.1 VSWR

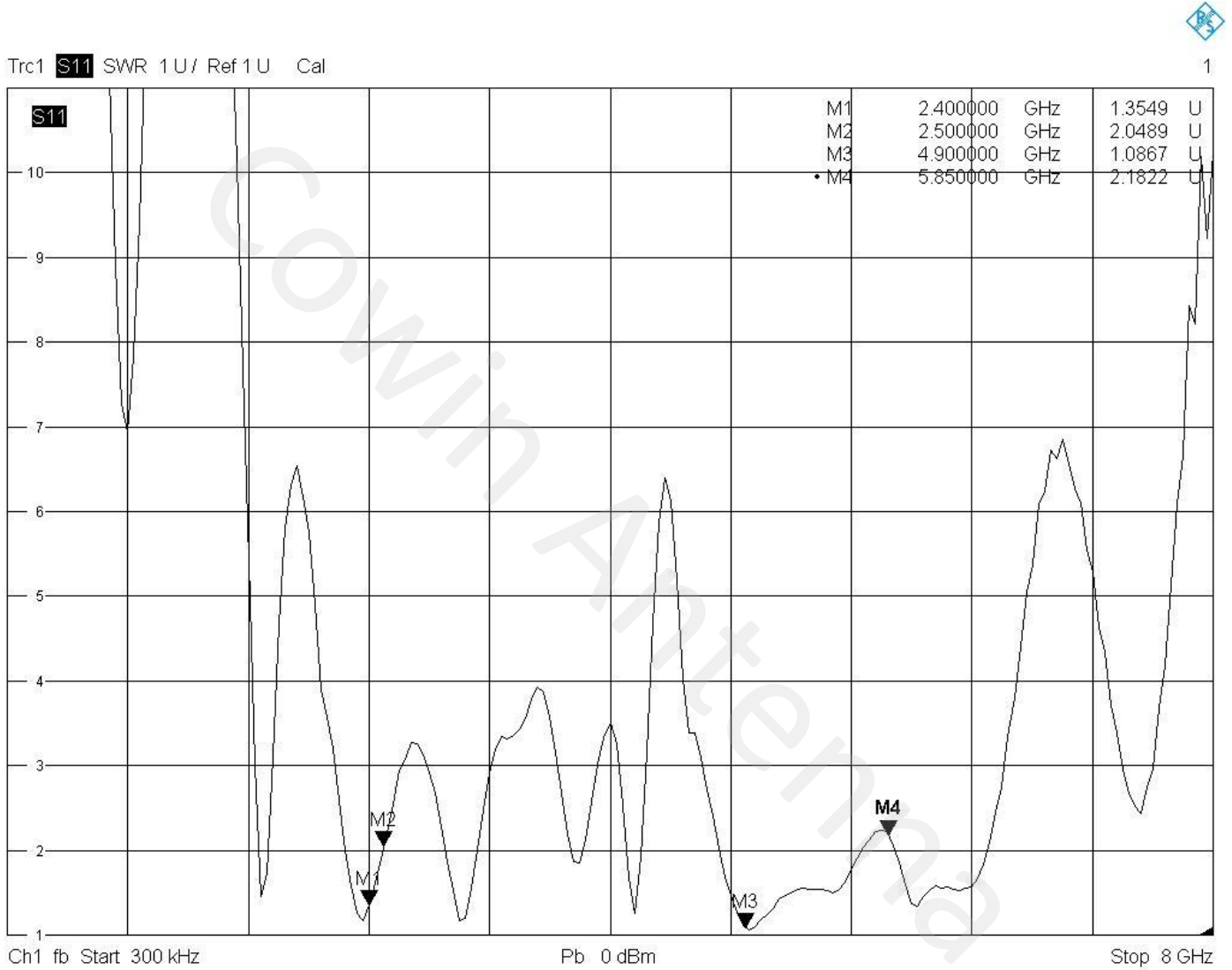

8/24/2021, 9:14 PM

4.2 Efficiency

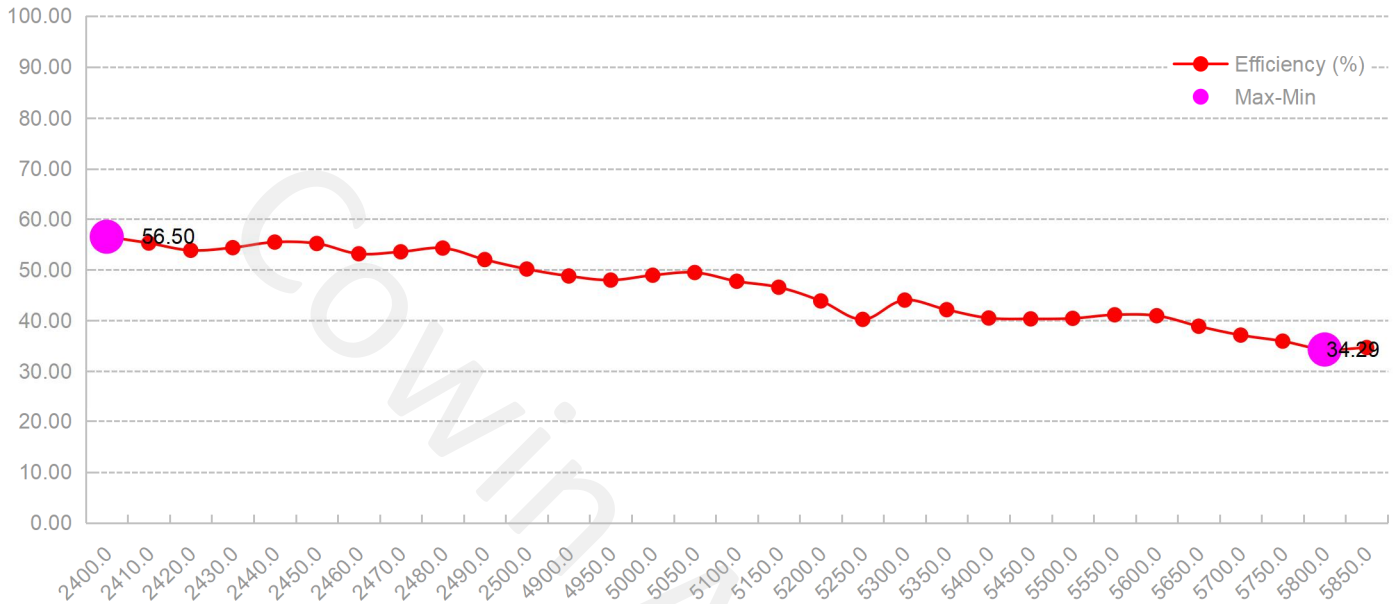

4.3 Peak gain

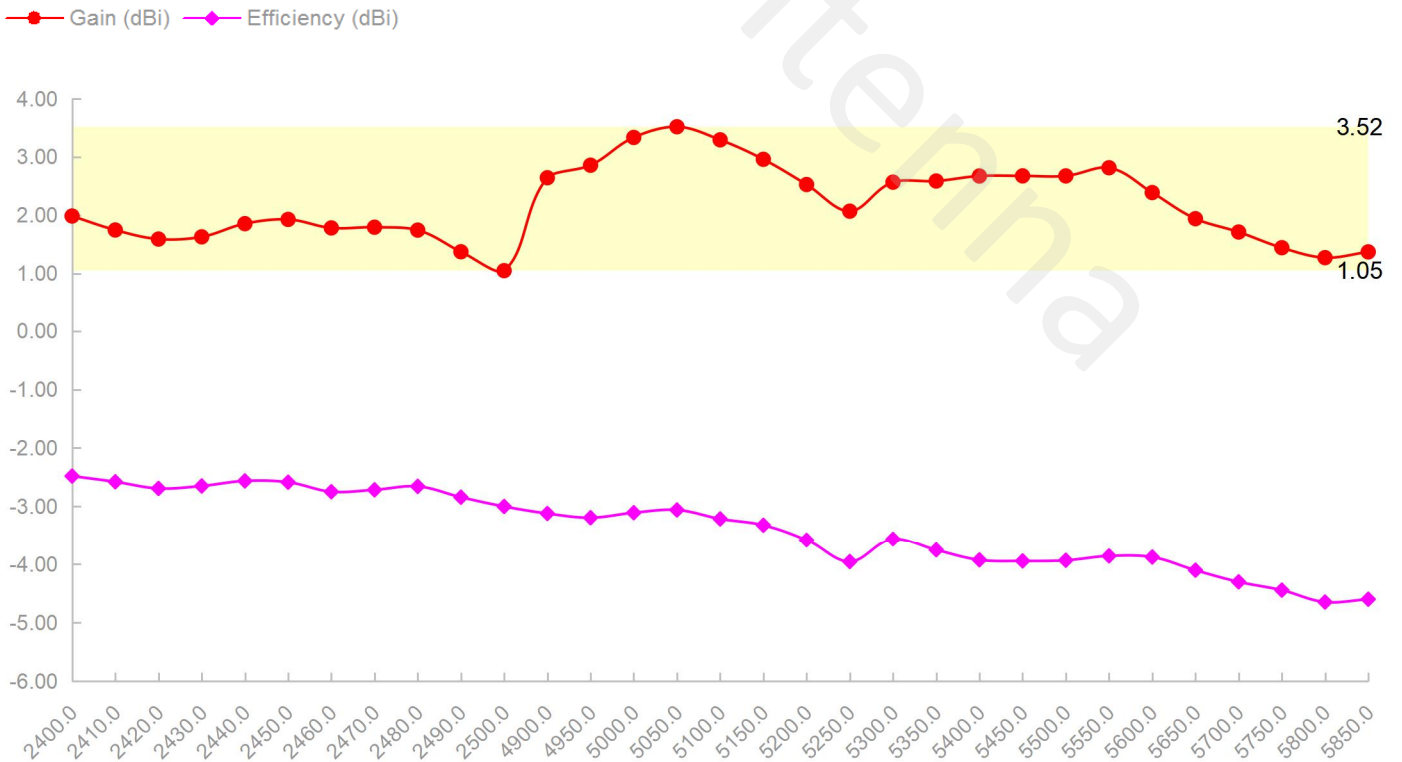

4.4 3D&2D Radiation Patterns

2400.0MHz H+V, Eff: 56.5%

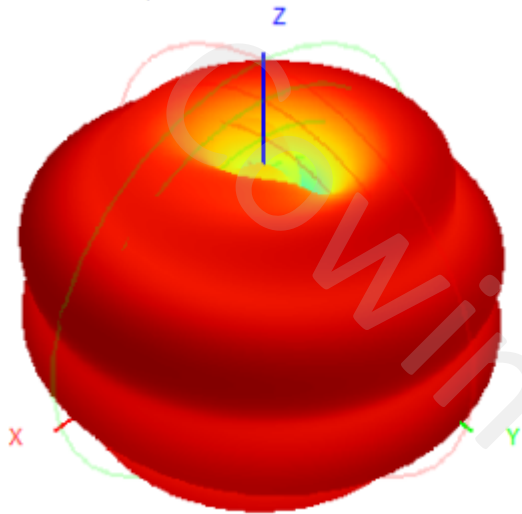

Back View

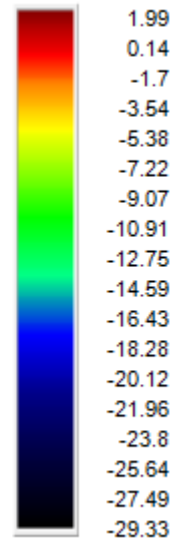
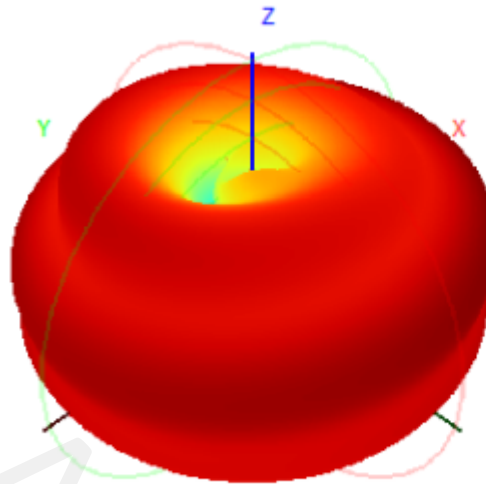

2400.0MHz Total(E1-XZ), Max= 1.97dBi

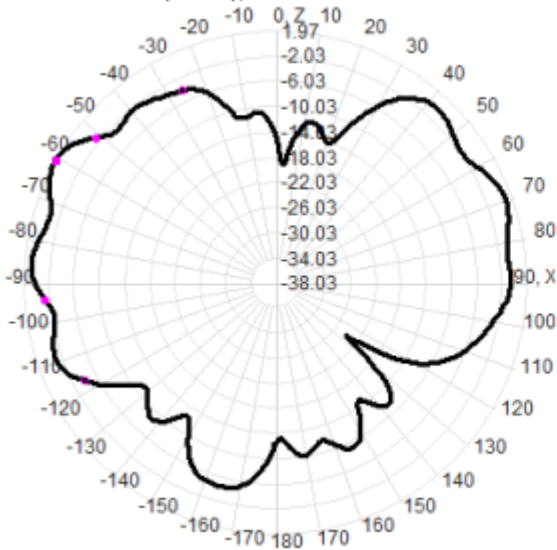

2400.0MHz Total(E2-YZ), Max= 1.54dBi

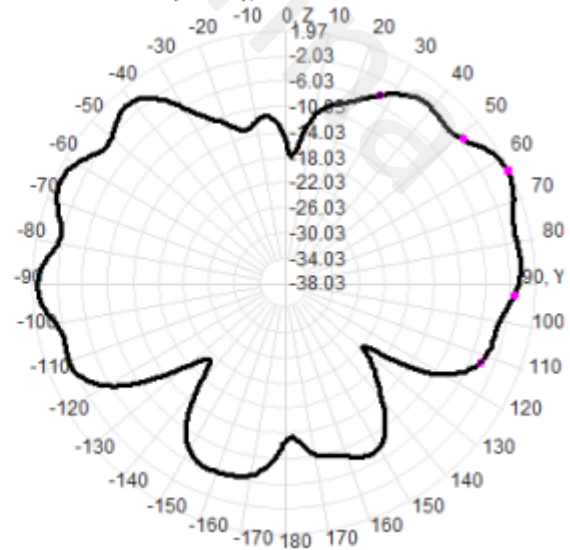

2450.0MHz H+V, Eff: 55.2%

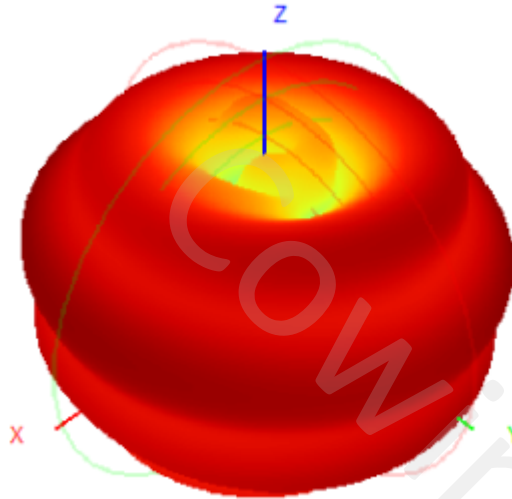

Back View

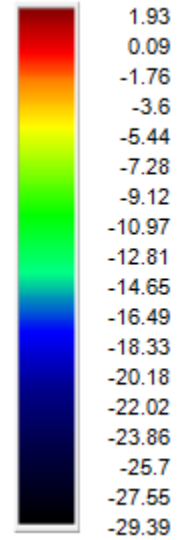
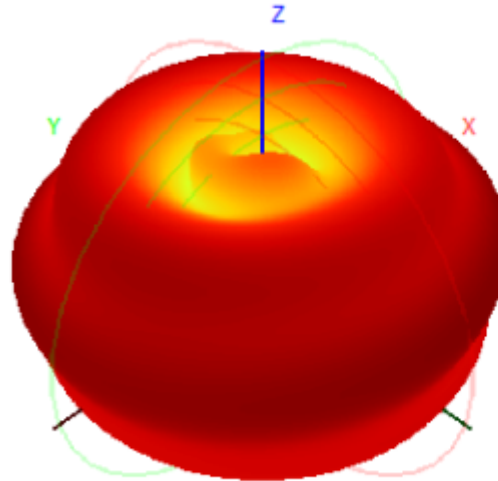

2450.0MHz Total(E1-XZ), Max= 1.40dBi

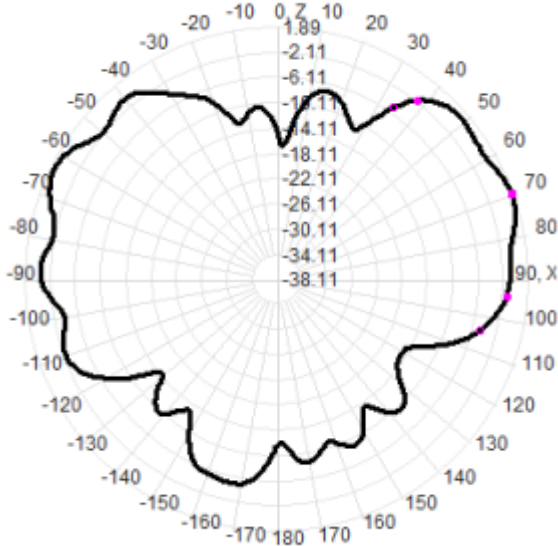

2450.0MHz Total(E2-YZ), Max= 1.89dBi

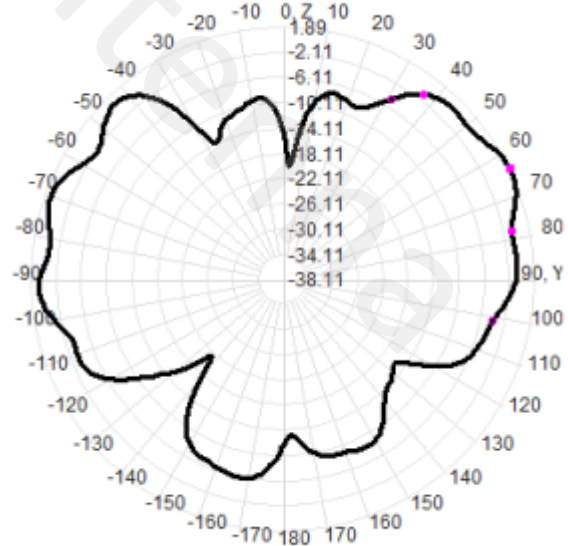

2500.0MHz H+V, Eff: 50.1%

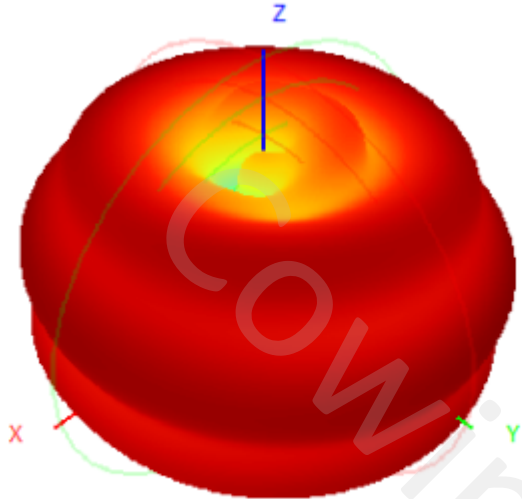

Back View

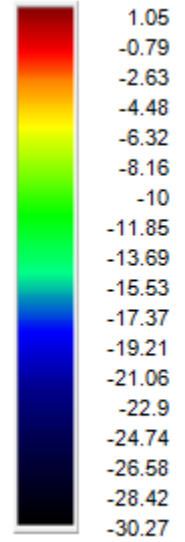
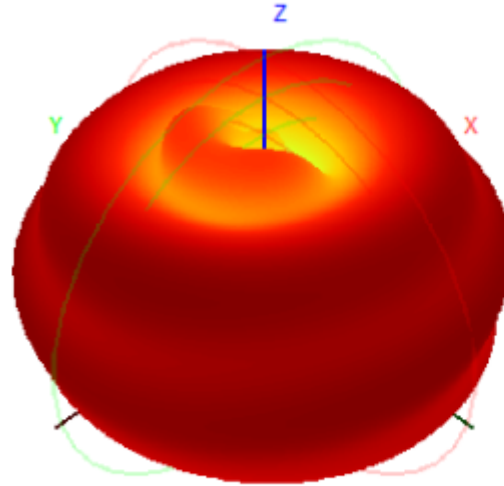

2500.0MHz Total(E1-XZ), Max= 0.82dBi

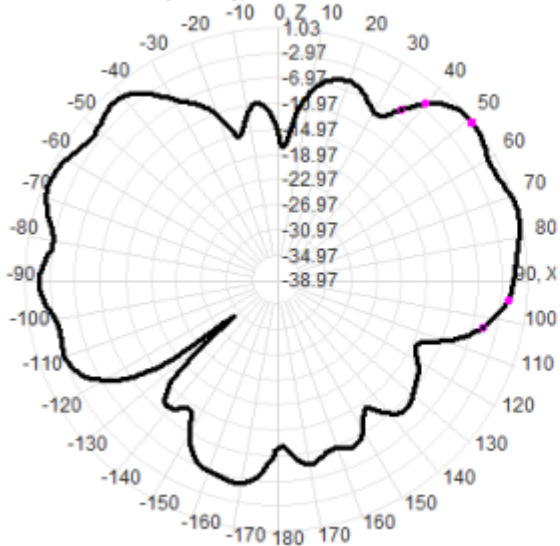

2500.0MHz Total(E2-YZ), Max= 1.03dBi

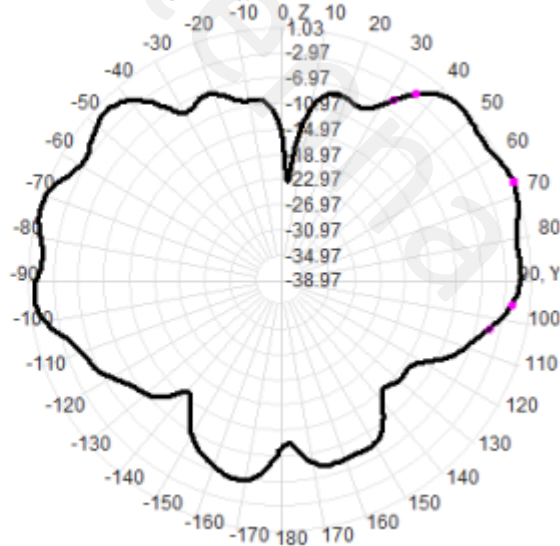

4900.0MHz H+V, Eff: 48.8%

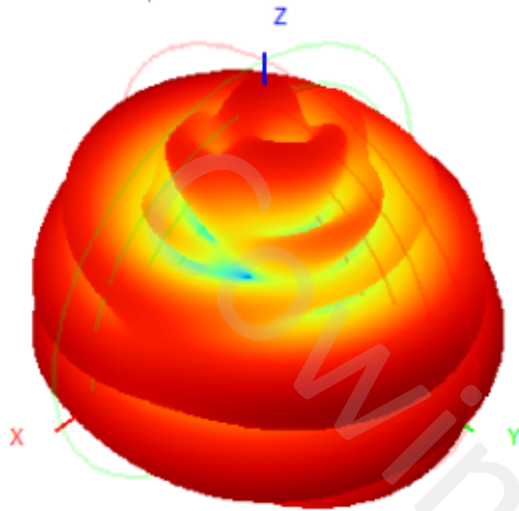

Back View

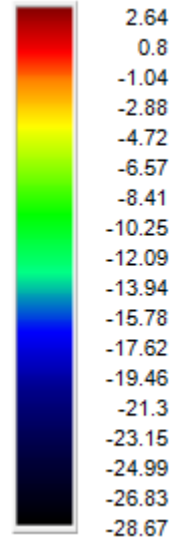
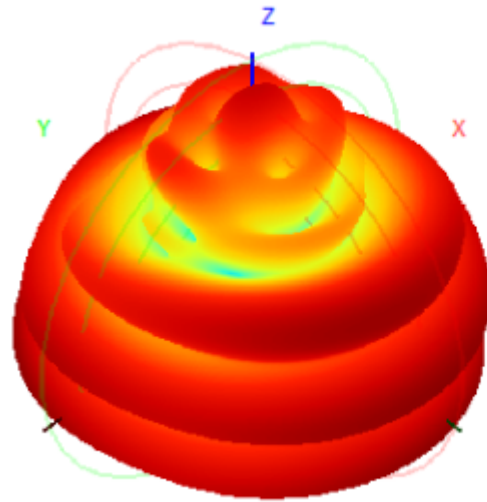

4900.0MHz Total(E1-XZ), Max= 1.27dBi

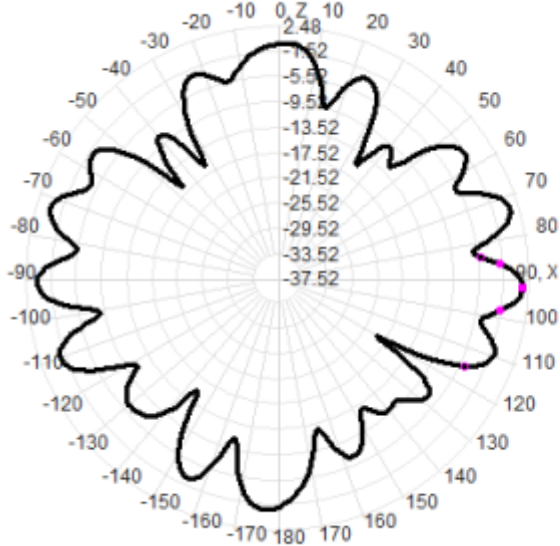

4900.0MHz Total(E2-YZ), Max= 2.48dBi

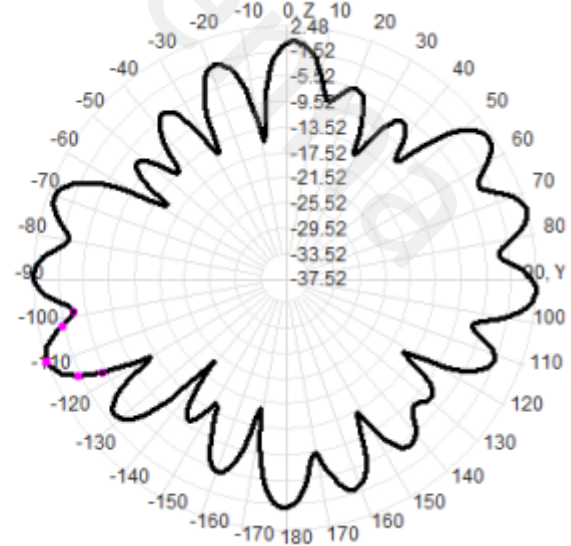

5150.0MHz H+V, Eff: 46.5%

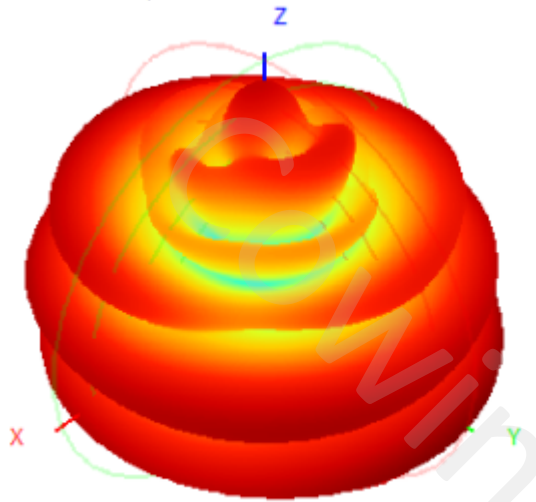

Back View

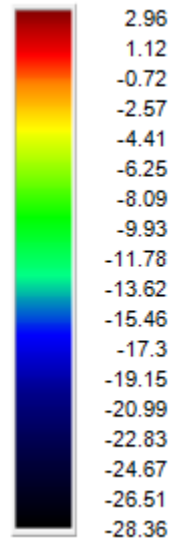
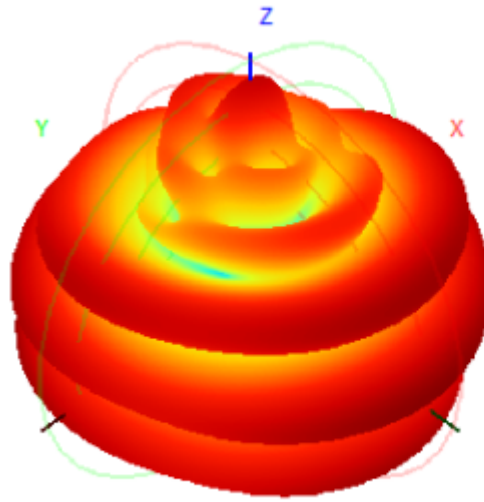

5150.0MHz Total(E1-XZ), Max= 0.99dBi

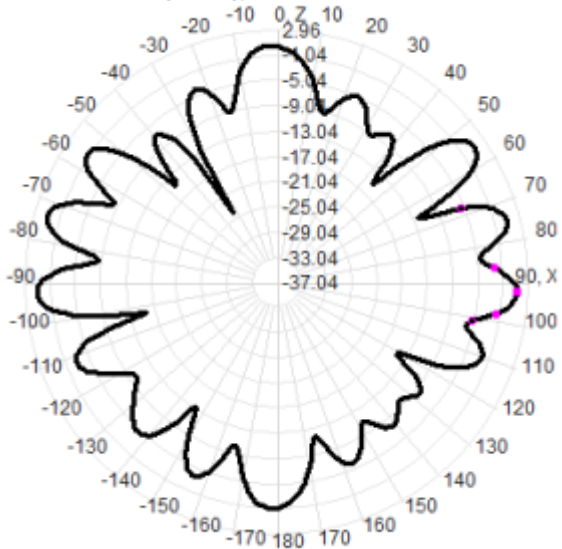

5150.0MHz Total(E2-YZ), Max= 2.96dBi

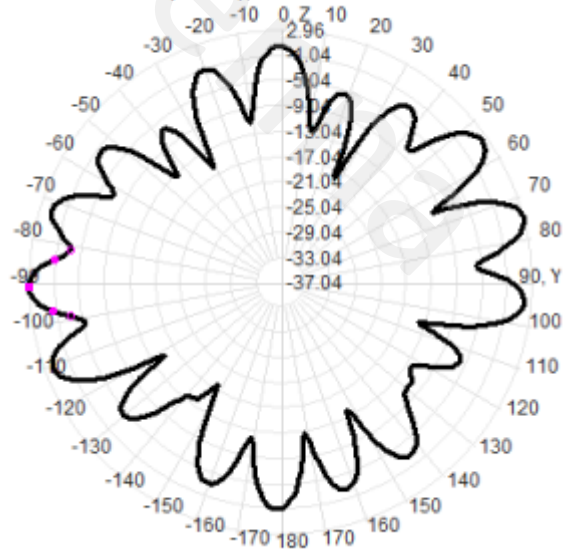

5400.0MHz H+V, Eff: 40.5%

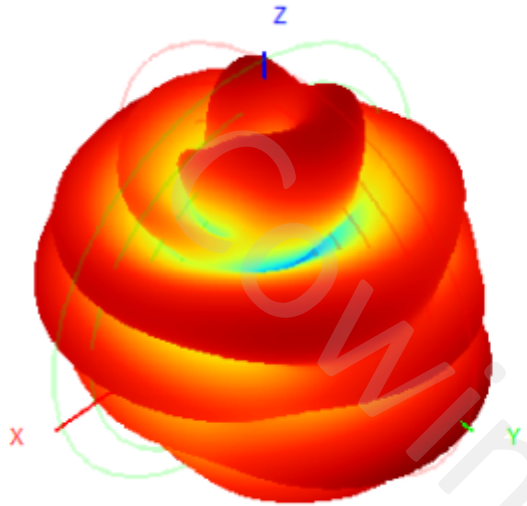

Back View

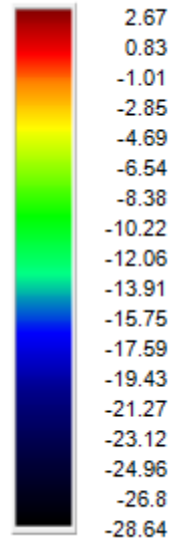
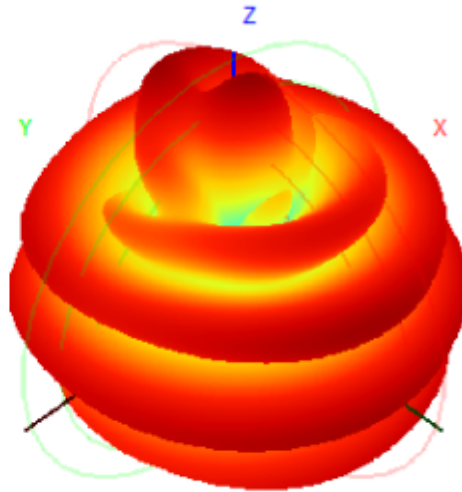

5400.0MHz Total(E1-XZ), Max= 0.55dBi

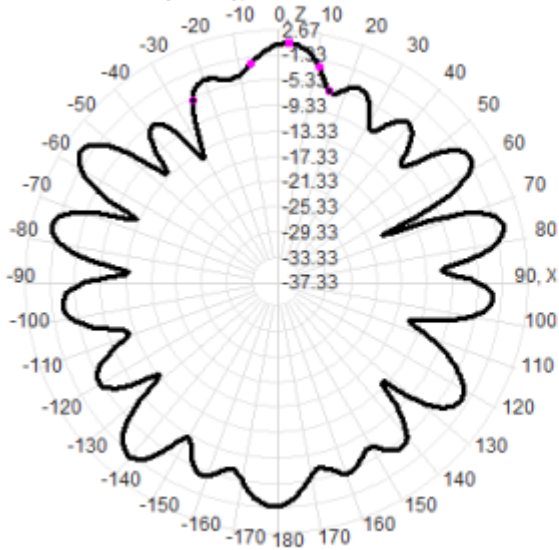

5400.0MHz Total(E2-YZ), Max= 2.67dBi

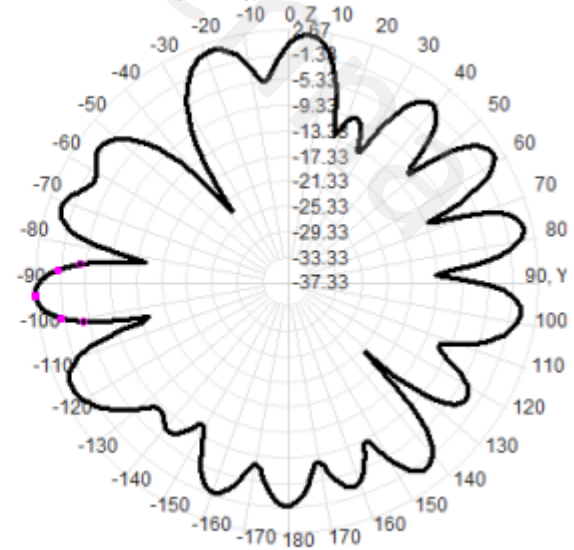

5850.0MHz H+V, Eff: 34.7%

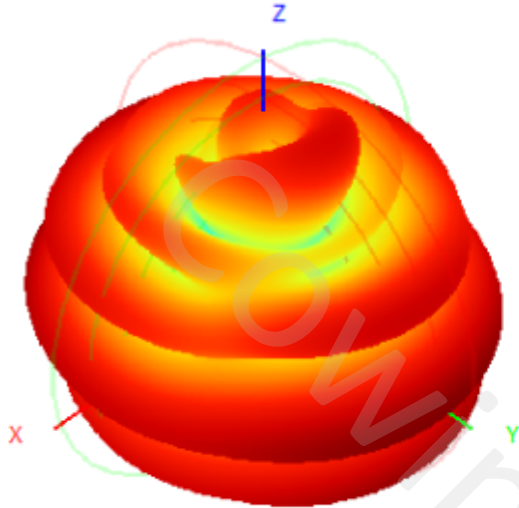

Back View

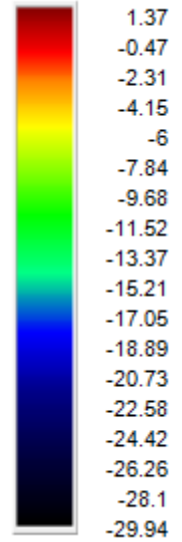
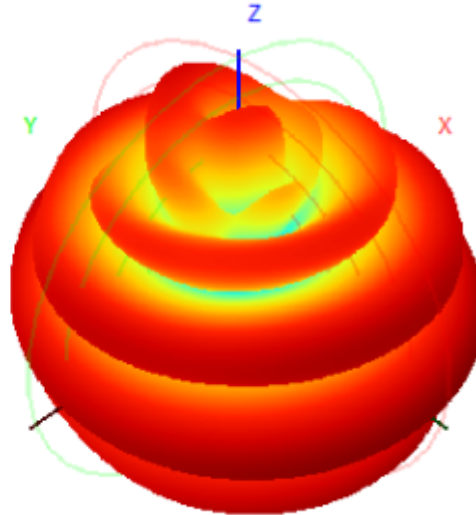

5850.0MHz Total(E1-XZ), Max= -0.88dBi

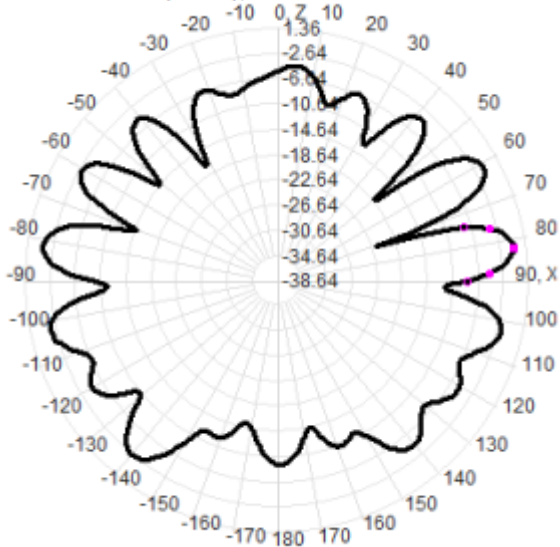

5850.0MHz Total(E2-YZ), Max= 1.36dBi

